

L 43WM

L 43WM is a surface mounted LED Direct / Indirect wall light with integral driver. This fitting is ideal for health care, age care, residential, hotels and restaurants. This slick indoor wall light comes in three different finishers, satin white, matt black powder coated and anodized finish.



The Blade L43WM is designed with minimal trim to seamlessly integrate in to your living space. This beautifully designed fitting comes with screw less end plates and opal diffuser.





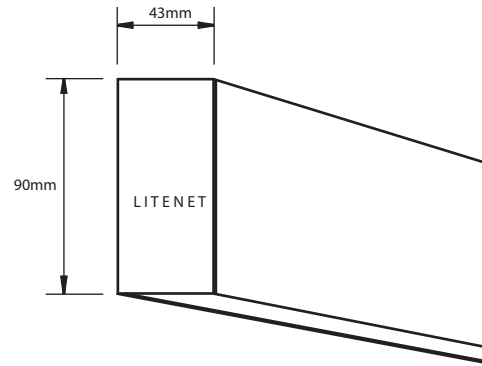
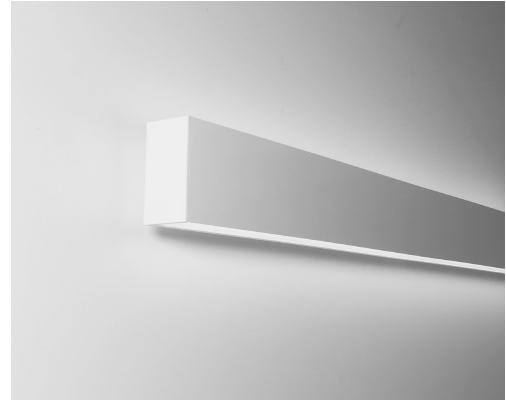

SMD LED Chip with 3-Step Mac-Adam Ellipse. Complete Non-dimmable ECG standard DALI Dim is available up on request.

Non-dimmable driver is standard DALI dim is available

50,000-hour 5-year warranty



-  SMD MacAdam Step 3 3000K / 4000K
-  DC25V -DC42V 250mA - 600mA
-  10-10V, DALI

-  WARRANTY INDOOR
-  IP 20
-  AC 240V
-  IES
-  DALI DIMMABLE
-  RCM EMC
-  WIDE BEAM

Power	20W/m UP 20W/m DOWN
LED	SMD
CCT	3000K / 4000K
Luminous flux	2550lm / 2932lm
Dimensions (L x H x W)mm	1200mm x 85mm x 41mm
Beam angle	90°
CRI	80
Part No 3000K	L43WM 40803
Part No 4000K	L43WM 40804

